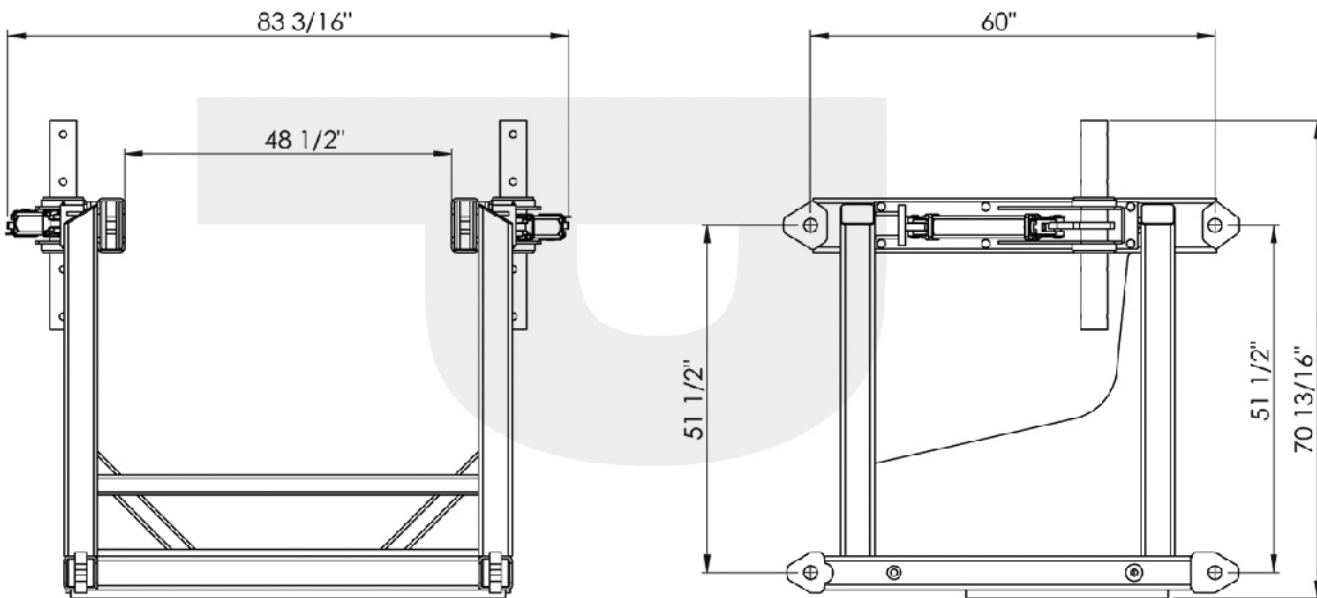

U-48 5 foot Pile Lead Section

#	WEIGHT	DESCRIPTION
4805 PGS	3,234 lbs	U-48 5 foot Pilegate Lead section w/ spotter and swivel plate